

# Installation Instructions

## Remote Controlled Spotlight Type DR2

### BEFORE YOU START

Read these instructions carefully. For the latest instructions on all our products see [www.rclighting.com/downloads](http://www.rclighting.com/downloads)

These instructions cover the following installation methods:

- A Monopoint Installation
- B 3-Circuit Installation
- C 2-Circuit Installation
- D 1-Circuit Installation
- E Hook Clamp Installation
- F Lamp Change - QR111
- G Accessory Change - QR111

If you have any difficulty installing this product please contact:

Remote Controlled Lighting Ltd (UK)  
42 Riverside Road, London SW17 0BA  
+44 (0) 20 8404 2400  
tech@rclighting.com

Remote Controlled Lighting Ltd (Asia)  
Unit 13, 8/F, Lai Sun Yuen Long Centre  
21-35 Wang Yip Street East,  
Yuen Long, Hong Kong  
T: +852 2310 9733  
F: +852 2310 9723  
asia\_sales@rclighting.com

### Important Safety Information

READ INSTRUCTIONS CAREFULLY BEFORE USING THIS PRODUCT. SAVE INSTRUCTIONS FOR LATER REFERENCE.

PRODUCT IS NOT SUITABLE FOR PHASE DIMMING

Products must be installed by a suitably qualified professional only. Installations must conform to national installation codes and accident prevention regulations.

If using a track adaptor, ensure it is compatible with the track system installed. Failure to do so may result in danger of electric shock and damage to the product.

Ensure electrical rating shown on product label conforms to mains voltage supply.

Do not modify the product in any way. RCL accepts no responsibility for damage caused by modifying this product.

**IP20** Product is rated IP20 unless otherwise stated. Install indoors only and away from damp or wet environments.

This symbol indicates the minimum distance to a lighted object and must be observed.

Caution, product will become hot in use. Allow to cool before touching.

Dispose of this product in accordance with WEEE or other national regulations.

Products marked with this symbol are compliant with Class 2 regulations.

## A Monopoint Installation

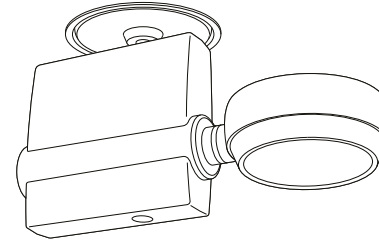

1 The monopoint fixture requires a *minimum* clearance distance of 200mm above and around the mounting point and a maximum ceiling material thickness of between 3mm and 35mm.

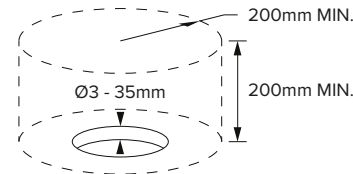

2 Mark up the ceiling and cut a circular hole 112-115mm in diameter.

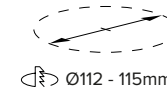

3 For multiple installations, ensure a *minimum* distance of 400mm between mounting points.

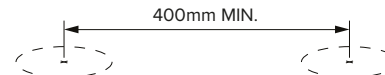

4 Insert the mounting ring into the hole so that it sits flush with the ceiling.

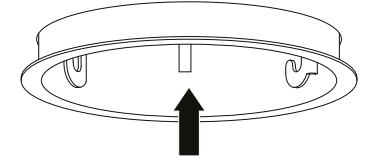

5 Holding the mounting ring in place, insert a fixing clip into a slot on the mounting ring.

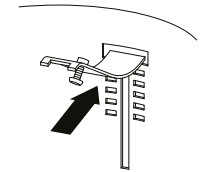

6 Slide the fixing clip down the slot until it hits the ceiling material.

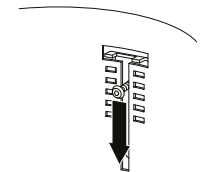

7 Insert fixing studs into mounting ring holes and, using a 2.5mm hex screwdriver, secure the clip in place. Repeat this process for each fixing clip.

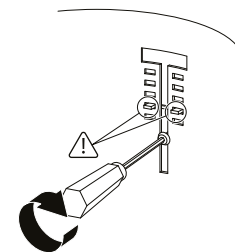

8 Ensure that the luminaire is securely installed, with the fixing clips firmly against the ceiling material.

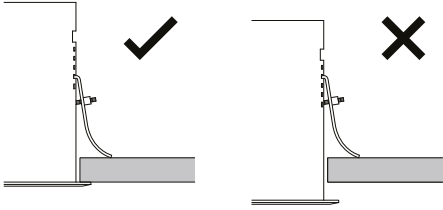

**⚠ WARNING**

- If for any reason the mounting ring cannot be fitted securely, stop the installation and contact RCL.

10 Run mains voltage cable to the hole and connect to the luminaire using an electrical connector (not supplied).

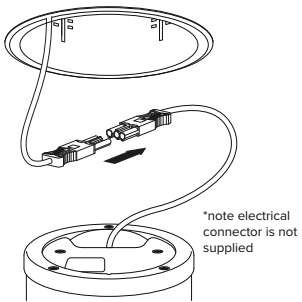

11 For projects that require DMX or DALI control, a 3-way connector will be present on the monopoint head.

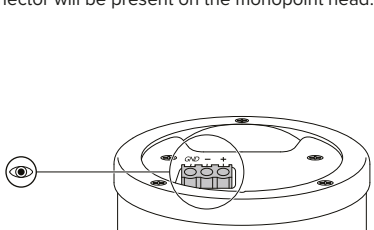

**✎ NOTES**

- For further instructions on DMX wiring and installation, please refer to DOC-083.
- DMX cable runs must be terminated using a 1W 120Ω resistor that is connected to the last 3-way connector in the spotlight chain.

12 If DMX or DALI control is specified, run appropriate cable to the mounting hole and connect to the monopoint head using the 3-way connector supplied

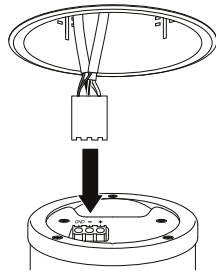

13 Insert DR2 Monopoint head into mounting ring.

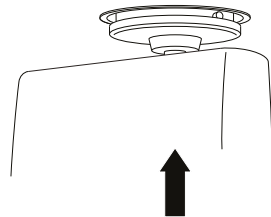

14 Twist spotlight clockwise and pull down gently to lock in place.

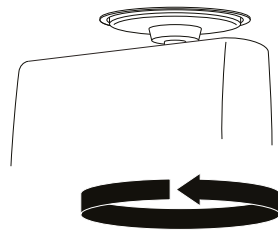

15 Ensure that the monopoint head studs locate securely in the mounting ring hooks, as shown below.

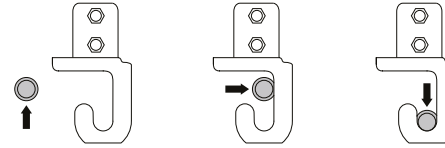

16 For multiple fixtures, Align primary hooks (denoted by a directional arrow) perpendicular to a feature such as a wall or trough edge to ensure all fixtures will align.

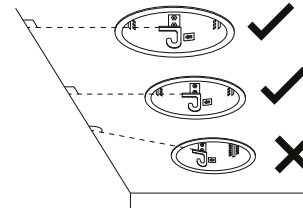

## B 3-Circuit Track Installation

1 Ensure the track adaptor is compatible with the 3-Circuit track system installed. Unless otherwise specified, the DR2 luminaire is supplied with a Eutrack 3-Circuit track adaptor as standard.

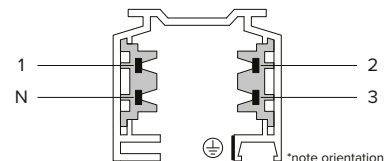

2 To mount the track adaptor into the track system, check that both tabs on the adaptor are in the open position and insert into the track.

**✎ NOTES**

- Ensure the track adaptor is orientated correctly. Align the earthing tabs (A) with the slot (B) on the track.
- Allow a minimum of 400mm between luminaire mountings.

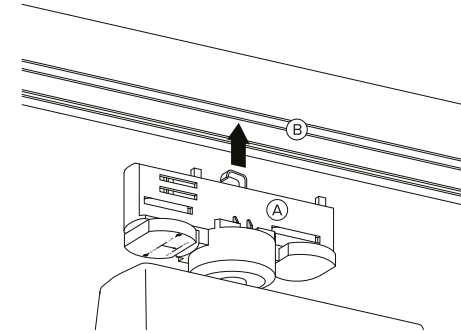

3 Rotate tab (C) clockwise 90° to connect the adaptor to the neutral circuit.

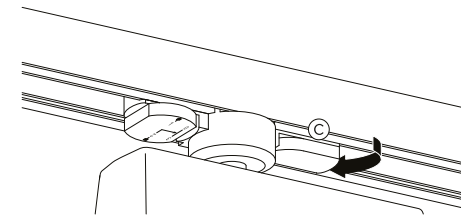

4 Rotate tab (D) to the desired circuit position (see section 5).

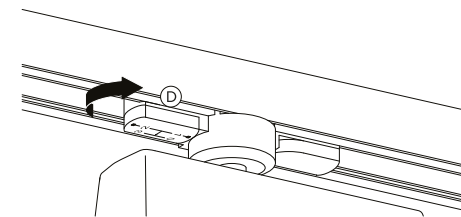

5 With the 3-Circuit track adaptor, you can choose which circuit the luminaire is connected to:

Unconnected - The luminaire is fixed to the track but not connected to any circuit.

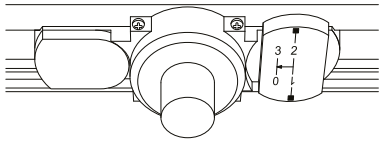

Circuit 1 - From the starting position, rotate the tab clockwise 90°.

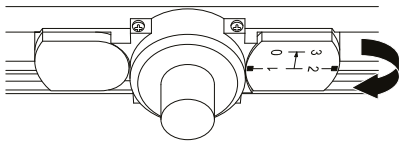

Circuit 2 - From the starting position, rotate the tab anti-clockwise 90°.

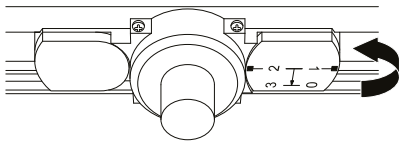

Circuit 3 - From the starting position, pull tab down ① and rotate the tab anti-clockwise 90° ②.

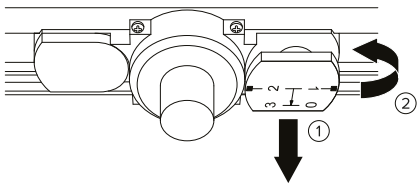

**NOTES**

- The Eutrac 3-Circuit track adaptor is compatible with a number of different 3-Circuit track systems including Eutrac, Erco & iGuzzini systems. For further options, please contact RCL.

## C 2-Circuit Track Installation

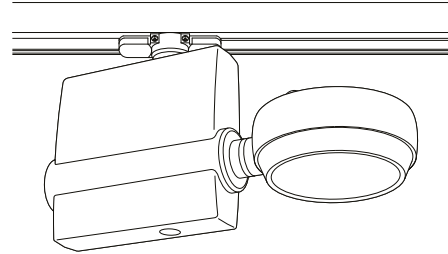

1 Ensure the track adaptor is compatible with the 2-Circuit track system installed.

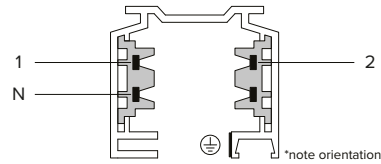

2 To mount the track adaptor into the track system, check that both tabs on the adaptor are in the open position and insert into the track.

**NOTES**

- Ensure the track adaptor is orientated correctly. Align the earthing tabs (A) with the slot (B) on the track.
- Allow a minimum of 400mm between luminaire mountings.

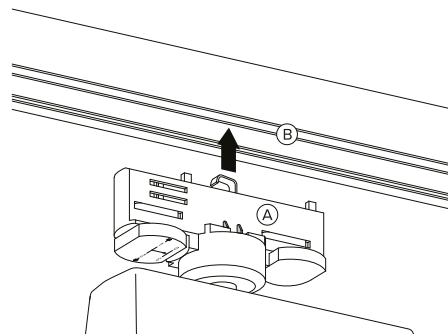

3 Rotate tab (C) clockwise 90° to connect the adaptor to the neutral circuit.

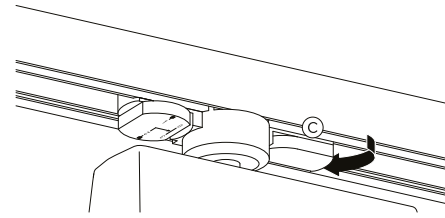

4 Rotate tab (D) to the desired circuit position (see section 5).

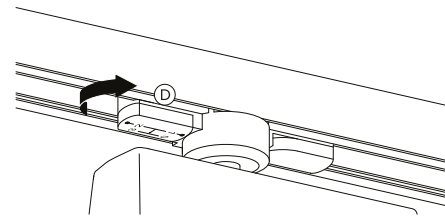

5 With the 2-Circuit track adaptor, you can choose which circuit the luminaire is connected to:

Unconnected - The luminaire is fixed to the track but not connected to any circuit.

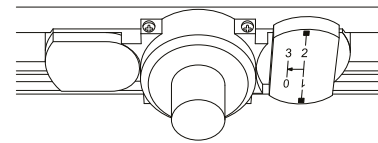

Circuit 1 - From the starting position, rotate the tab clockwise 90°.

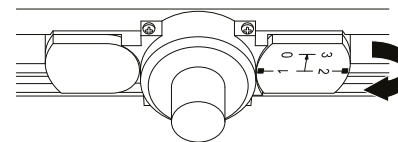

Circuit 2 - From the starting position, rotate the tab anti-clockwise 90°.

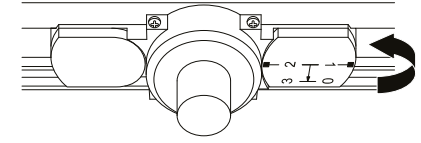

## D 1-Circuit Track Installation

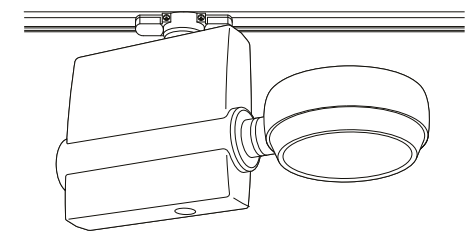

1 Ensure the track adaptor is compatible with the 1-Circuit track system installed. Unless otherwise specified, the DR2 luminaire is supplied with a Eutrac 1-Circuit track adaptor as standard.

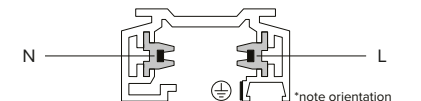

2 To mount the track adaptor into the track system, check that both tabs on the adaptor are in the open position and insert into the track.

**NOTES**

- Ensure the track adaptor is orientated correctly. Align the earthing tabs (A) with the slot (B) on the track.
- For multiple fixtures, allow a *minimum* of 400mm between luminaire mountings.

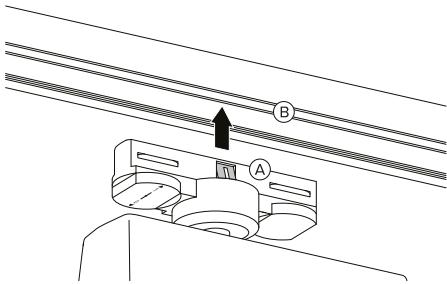

3 Rotate tab (C) clockwise 90° to connect the adaptor to the neutral circuit.

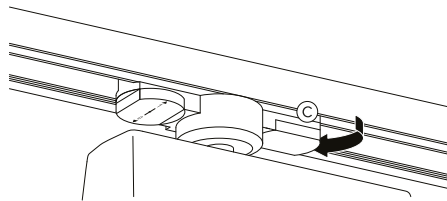

Rotate tab (D) clockwise 90° to connect the adaptor to circuit 1.

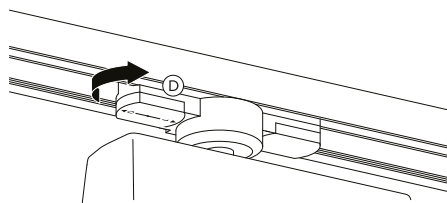

Rotate tab (D) anti-clockwise (from starting position) 90° to connect the adaptor to the neutral circuit.

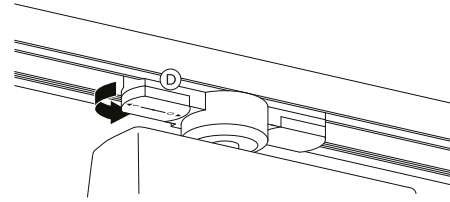

**NOTES**

- The Eutrac 1-Circuit track adaptor is compatible with the Eutrac 1-Circuit track system. For compatibility with other systems, please check with RCL.
- To move the luminaire's location on the track, rotate both tabs to the *open* position before moving.

## E Hook Clamp Installation

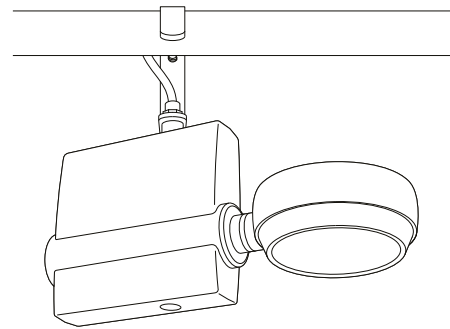

1 The hook clamp fixture fits barrel bar with a minimum diameter of Ø40mm and a maximum diameter of Ø50mm.

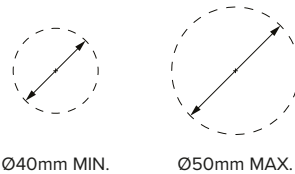

2 Hook the hook clamp over the barrel bar and screw in retaining bolt to secure the fixture in place.

**NOTES**

- For multiple fixtures, allow a *minimum* of 400mm between luminaire mountings.

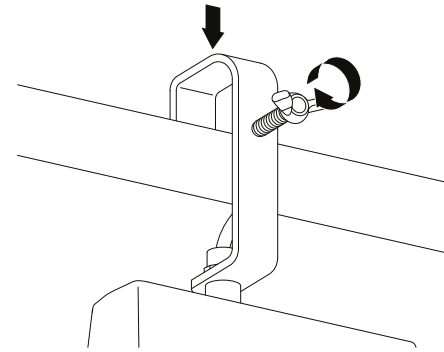

3 Hook clamp should be mounted vertically.

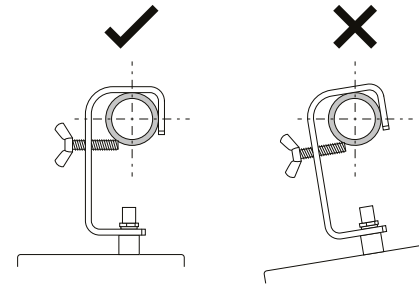

4 For multiple fixtures, ensure that hook clamp orientation is the same for each mounting.

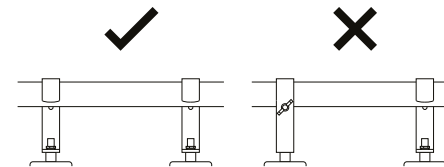

5 Run mains voltage cable to the hook clamp fixture and connect to the luminaire using an electrical connector (not supplied).

**NOTES**

- The DR2 luminaire contains an integral transformer/ballast and should be wired directly to the mains voltage supply.
- It may be necessary to secure the mains cable to the barrel bar to avoid it blocking rotation of the luminaire.

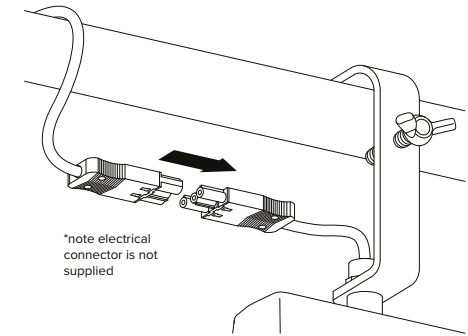

## F Lamp Change - QR111

1 Disconnect product from mains voltage supply and allow to cool before replacing lamp.

2 Pull back the wishbone arm holding the lamp.

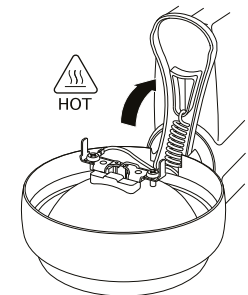

- 3 Unscrew lamp screws and remove the lamp connectors.

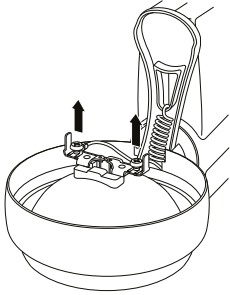

- 4 Remove lamp and dispose of correctly. To install a new lamp, reverse this process ensuring screws are tight. Loose screws cause damage.

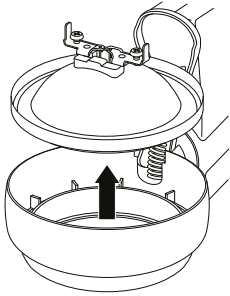

## G Accessory Change - QR111

- 1 Remove lamp, as shown in section F (for QR-CBC51 version, contact RCL).  
2 To add a honeycomb louvre, simply insert into accessory ring and replace lamp.

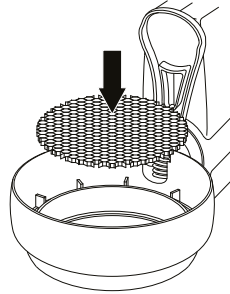

- 3 To add a lens or filter, remove standard accessory ring.

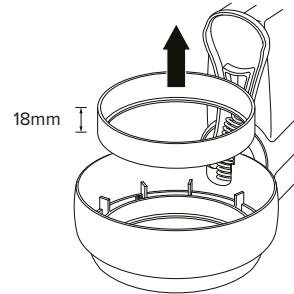

- 4 Insert the desired lens or filter, followed by the short accessory ring (sold separately) and replace lamp.

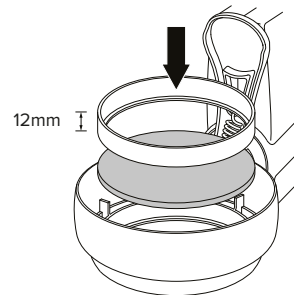

If you have any difficulty installing this product please contact:

Remote Controlled Lighting Ltd (UK) | 42 Riverside Road, London SW17 0BA  
+44 (0) 20 8404 2400 | [tech@rclighting.com](mailto:tech@rclighting.com)

Remote Controlled Lighting Ltd (Asia) | Unit 13, 8/F, Lai Sun Yuen Long Centre  
21-35 Wang Yip Street East, Yuen Long, Hong Kong  
T: +852 2310 9733 | F: +852 2310 9723  
[asia\\_sales@rclighting.com](mailto:asia_sales@rclighting.com)

Copyright © 2017 Remote Controlled Lighting Ltd. All Rights Reserved.